

# ***Electric Motor Greasing The Basics***

*Howard W Penrose, Ph.D., CMRP*

***SUCCESS by DESIGN***

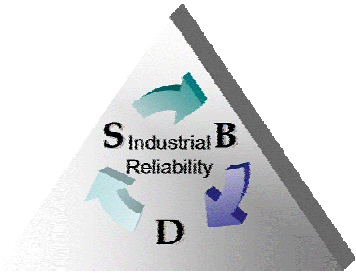

# Ball Bearing

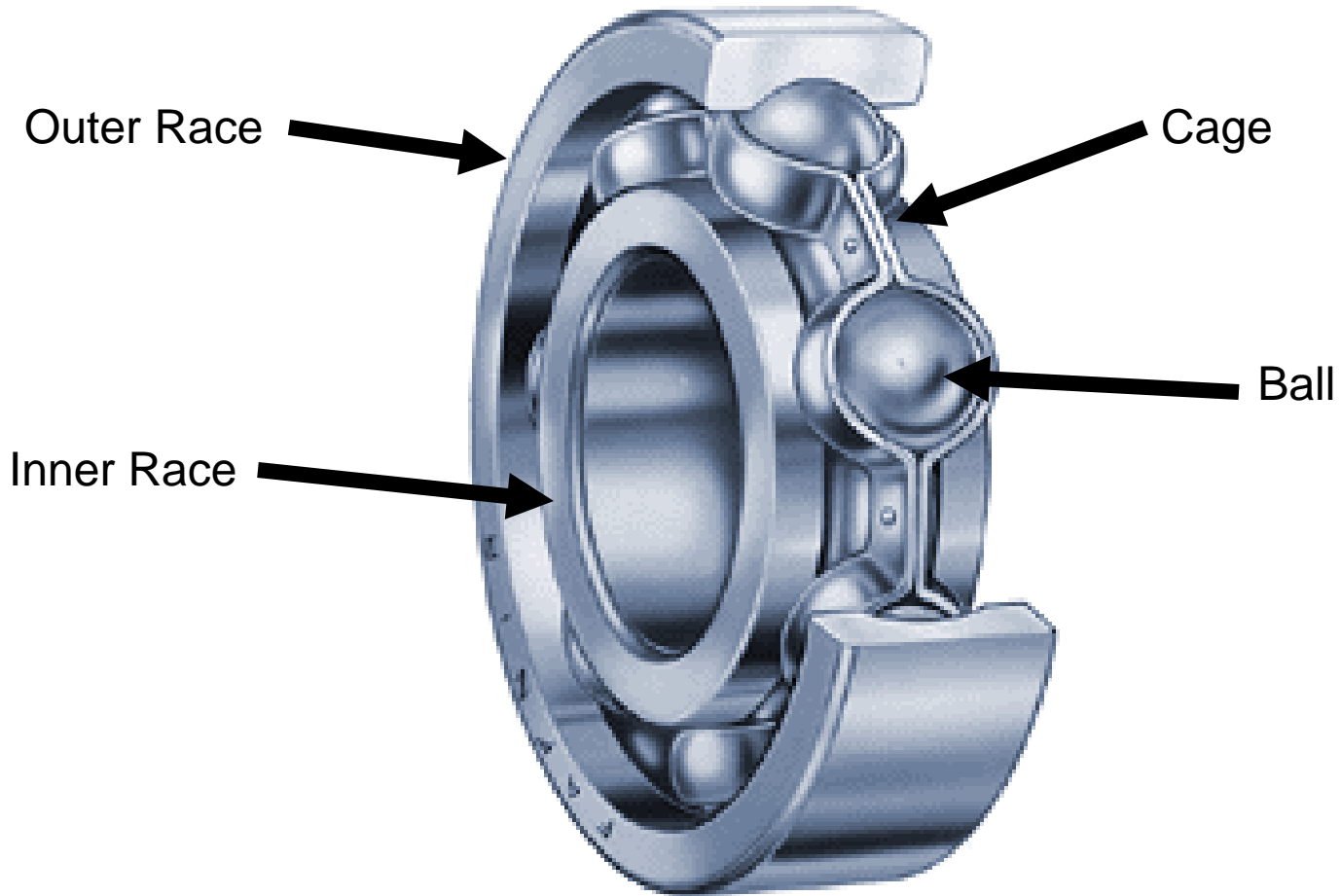
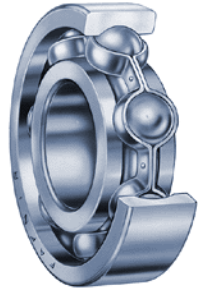

(c)2005, SBD

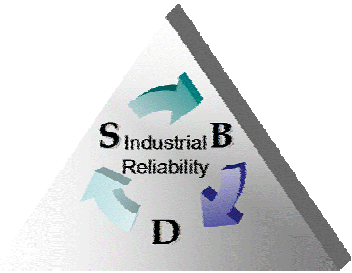

# Roller Bearing

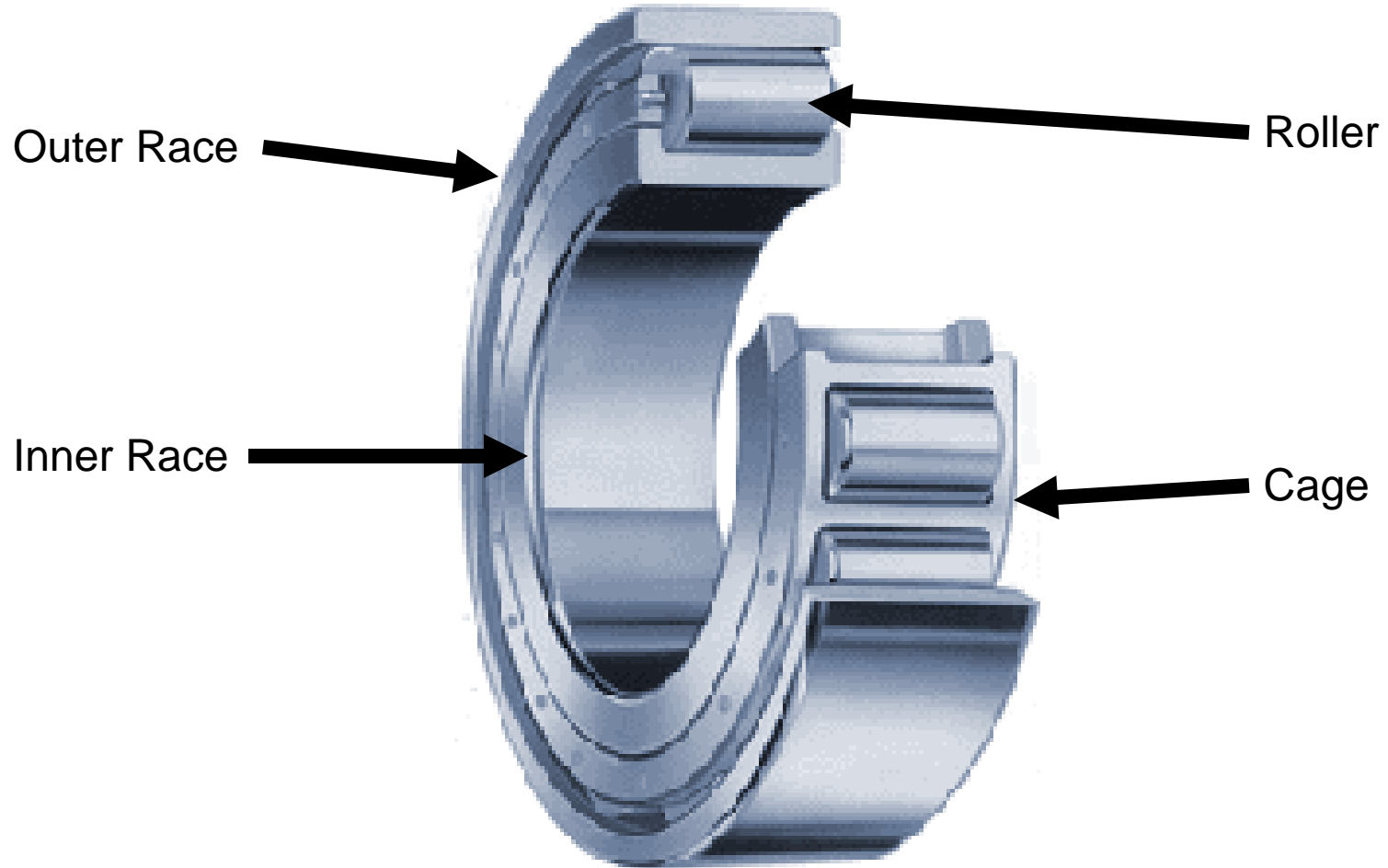
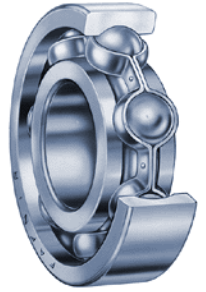

(c)2005, SBD

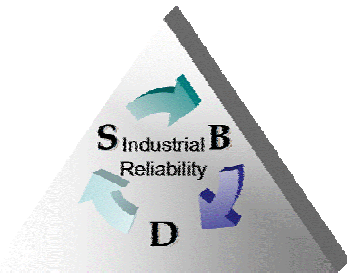

# Race Materials

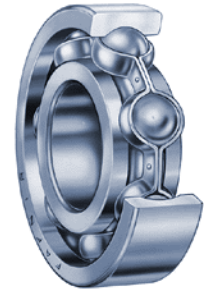

- Through-Hardening Steel, General Purpose: 1.5% Chromium, 1% Carbon
- Case-Hardening Steel, General Purpose: Chromium-Nickel and Manganese-Chromium Alloyed Steel (0.15% Carbon)
- Chromium or Chromium Molybdenum Stainless Steel, Corrosion Resistant: Lower loading due to reduced hardening
- Hybrid Ceramic: Steel inner/Outer races – has greater stiffness, can operate at higher speeds and temperatures

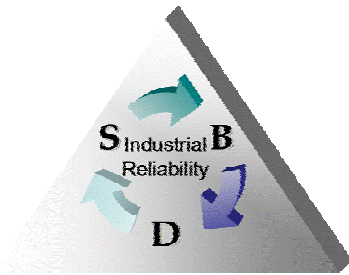

# Cage Materials

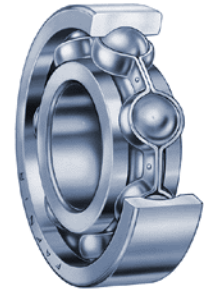

- Molded Polyamide: Glass fiber reinforced polyamide (-40 to 250F)
- Steel: Reduced friction and wear
- Machined Bronze: Heavy duty and larger bearings. Can be used up to 450F. Resistant to corrosive attack.
- Brass: Small to medium bearings up to 450F.
- Phenolic (Bakelite): Machined, cotton fabric impregnated with phenolic resin. High speed applications less than 225F.

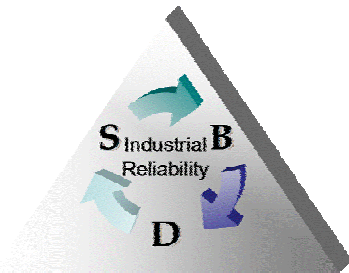

# Shields and Seals

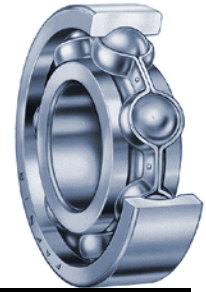

Selection Criteria	Shield/Seal Type		
	Shielded	Noncontact Shield	Contact Seal
Torque	Small	Small	Large as compared because of contact lip mechanism
High-Speed	Same as open brgs	Same as open brgs	Limited, owing to contact seal characteristics
Grease Retention	Good	Better than shield	Slightly better than non-contact type
Dust Prevention	Good	Better	Excellent
Waterproofing	Unsuitable	Unsuitable	Good (usable under water spray)
Heat Resistivity	Depending on grease	Intermittant 266F, continuous 248F	Intermittant 248F, continuous 212F
Operating Temperature	140F	140F	190F starting, 170F continuous
Greasable	Yes	Yes	No

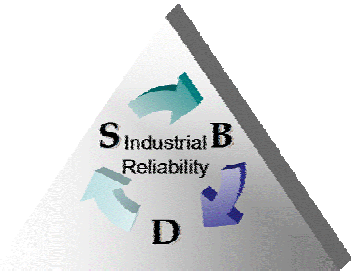

# Bearing Housing

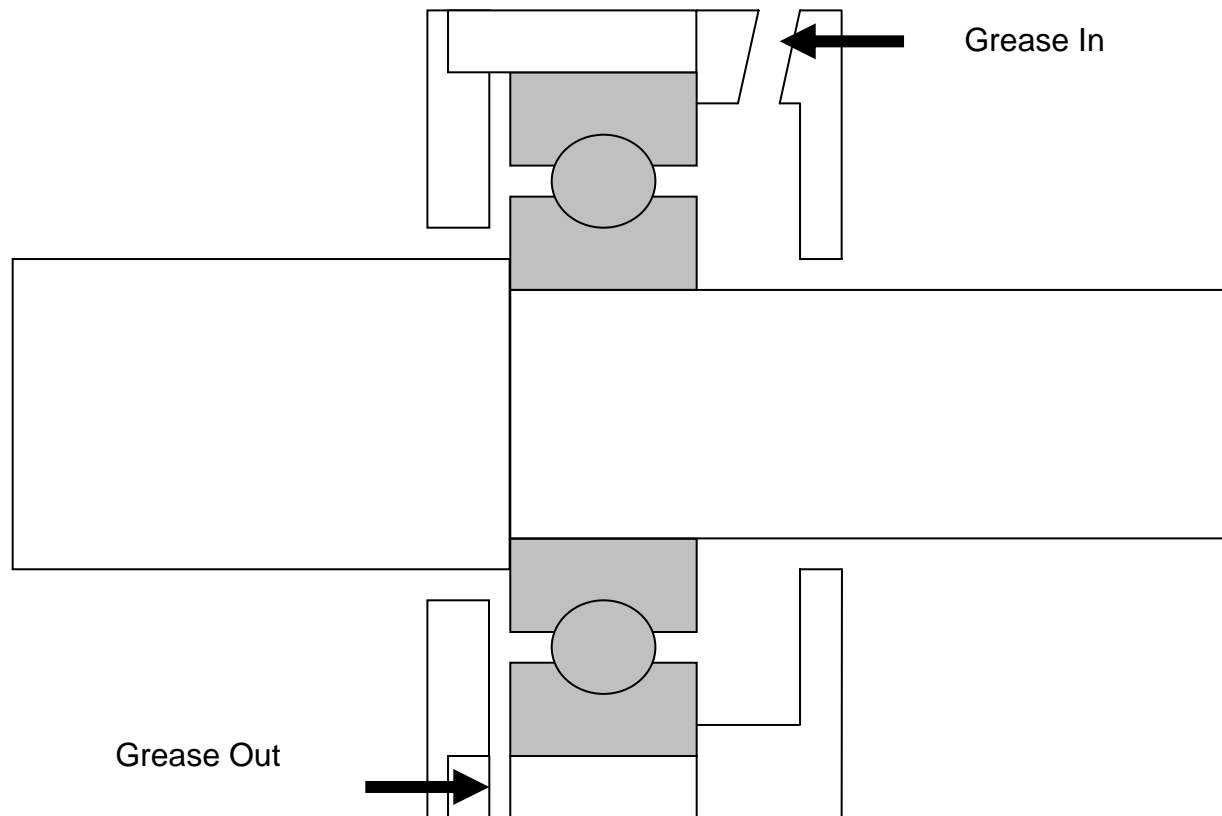
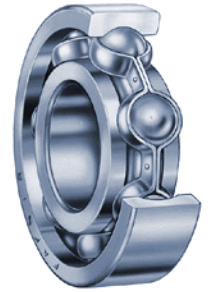

(c)2005, SBD

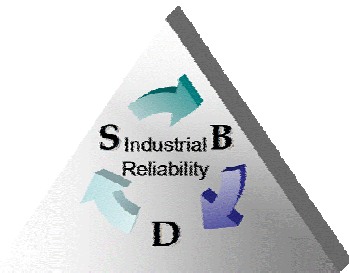

# Grease Classification

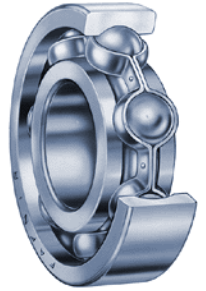

- Group I – General Purpose: Greases that are expected to give proper lubrication to bearings whose temperatures vary from -40 to 250F
- Group II – High Temperature Greases: Greases that are expected to give proper lubrication to bearings whose operating temperatures vary from 0 to 300F
- Group III – Medium Temperature Greases: Operating temps from 32 to 200F
- Group IV – Low Temperature Greases: Operating temps from -67 to 225F
- Group V – Extreme High Temperature Greases: Operating temps up to 450F



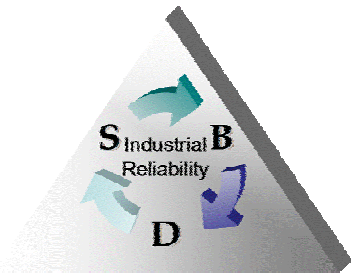

# Grease Base Temps

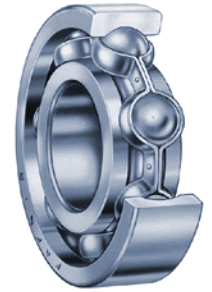

Base	Lower (F)	Upper (F)
Lithium Base	-22	230
Lithium Complex	-4	284
Sodium Base	-22	176
Sodium Complex	-4	284
Calcium Base	14	140
Calcium Complex	-4	266
Barium Complex	-4	266
Aluminum Complex	-22	230
Inorganic Thickeners	-22	266
Polyurea	-22	284

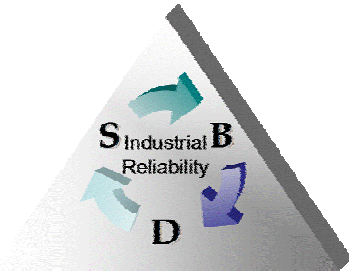

Compatibility	Aluminum Complex	Barium	Calcium	Calcium 12-Hydroxy	Calcium Complex	Clay	Lithium	Lithium 12-Hydroxy	Lithium Complex	Polyurea
Aluminum Complex	X	I	I	C	I	I	I	I	C	I
Barium	I	X	I	C	I	I	I	I	I	I
Calcium	I	I	X	C	I	C	C	B	C	I
Calcium 12-Hydroxy	C	C	C	X	B	C	C	C	C	I
Calcium Complex	I	I	I	B	X	I	I	I	C	C
Clay	I	I	C	C	I	X	I	I	I	I
Lithium	I	I	C	C	I	I	X	C	C	I
Lithium 12-Hydroxy	I	I	B	C	I	I	C	X	C	I
Lithium Complex	C	I	C	C	C	I	C	C	X	I
Polyurea	I	I	I	I	C	I	I	I	I	X

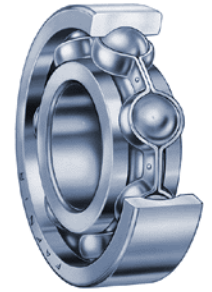

I = Incompatible

C = Compatible

B = Borderline

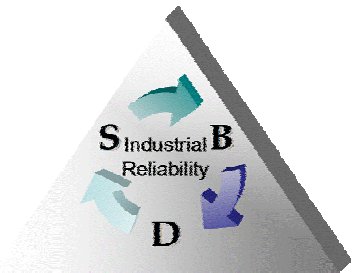

# Greasing Table

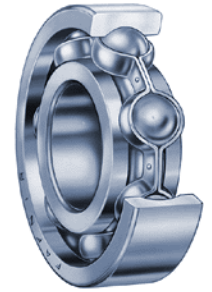

Bearing No	Amount (cubic inches)	Equivalent Teaspoons	Bearing No	Amount (cubic inches)	Equivalent Teaspoons
<b>203</b>	0.15	0.5	<b>219</b>	2.8	7.2
<b>205</b>	0.27	0.9	<b>222</b>	3	10
<b>206</b>	0.34	1.1	<b>307</b>	0.53	1.8
<b>207</b>	0.43	1.4	<b>308</b>	0.66	2.2
<b>208</b>	0.52	1.7	<b>309</b>	0.81	2.7
<b>209</b>	0.61	2	<b>310</b>	0.97	3.2
<b>210</b>	0.72	2.4	<b>311</b>	1.14	3.8
<b>212</b>	0.95	3.1	<b>312</b>	1.33	4.4
<b>213</b>	1.07	3.6	<b>313</b>	1.54	5.1
<b>216</b>	1.49	4.9	<b>314</b>	1.76	5.9

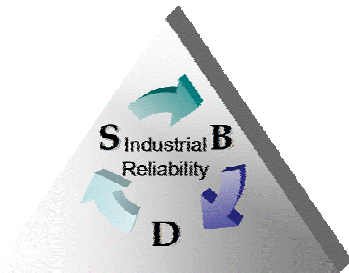

# Bearing Grease Fill

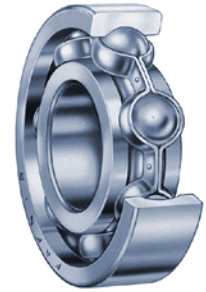

Brg Manufacturer	Double Shield, %	Open or Single, %	Housing Cavity, %
Fafnir	25-50	100	33
FAG	30-40	30-40	100 <0.2; 35% >0.2 speed ratio
FIT	15-20		
Gen Brg Corp	30	30	
IKO	50	50	
INA	20-80	20-80	
KBC	12.5-25		
Koyo	30-50	100	
McGill	<50	<50	100
MRC	30	80-90	50
NACHI	20-30	30-50	33-50
NSK	35	25-40	50
NTN	30-35	30-35	<50

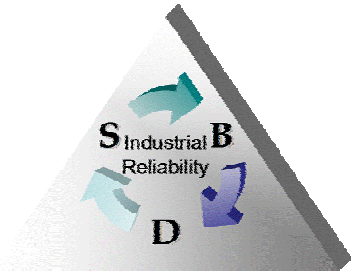

# Bearing Grease Fill

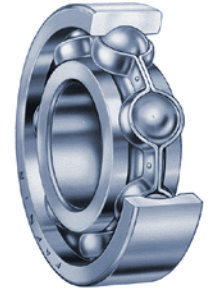

Brg Manufacturer	Double Shield, %	Open or Single, %	Housing Cavity, %
PEER	33		
SKF	25-35	100	33
SNR	33	20-30	
STEYR		100	
ZVL-ZKL	33-55	30	30

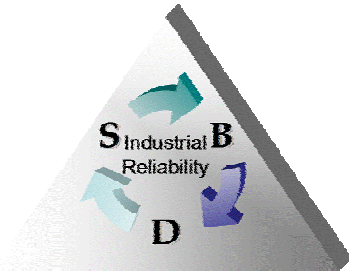

# Greasing Frequency

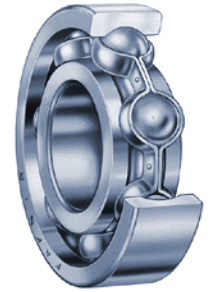

RPM	Frame Range	2000 hrs/yr	8000 hrs/yr
<b>3600 (2-Pole)</b>	284T-286T	6 months	2 months
	324T-587U	4 months	2 months
<b>1800 (4-Pole)</b>	284T-326T	4 years	18 months
	364T-365T	1 year	4 months
	404T-449T	9 months	3 months
	505U-587U	6 months	2 months
<b>1200 and below</b>	284T-326T	4 years	18 months
	364T-449T	1 year	4 months
	505U-587U	9 months	3 months

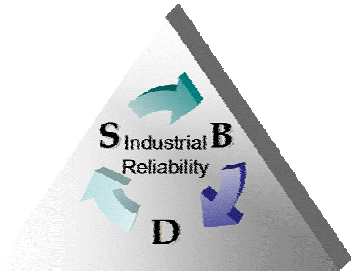

# Thermal Considerations

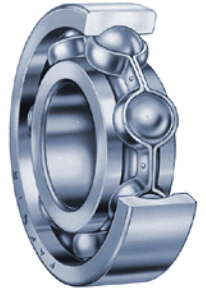

- Regreasing doubled for every 15C increase in motor operating temp
- Shielded bearings will operate ~5C hotter than open bearings
- TEFC will have a normal rise that will not exceed 45C up to 1800RPM and 50C for 3600RPM if average winding temp does not exceed 80C
- Outer race temperature may be fairly close, depending on the influence of cooling air.

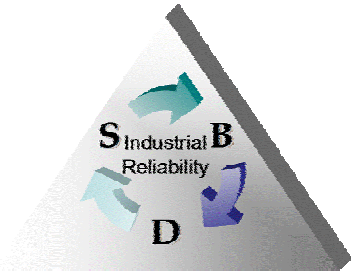

# Bearing Temp Trip Limits

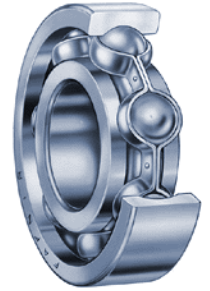

	Standard Lubricants	Synthetic Lubricants
Normal	80-90C	110-115C
Alarm	90-95C	120-125C
Shutdown	100-105C	130-135C

For General Purpose Applications  
By RTD or Surface Temp



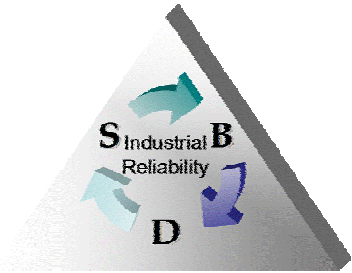

# Grease Guns: Manual and Electric

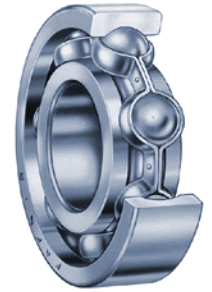

- 5,000-6,000 lbs pressure
  - Note: Bearings can only stand 500 lbs
- ~2 oz/100 strokes or 0.090 cubic inches per stroke (depends on manufacturer)

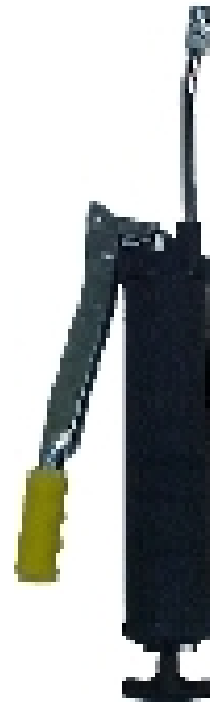

Manual



Motorized

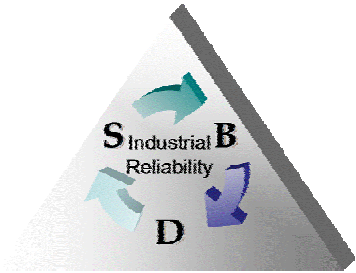

# Greasing Considerations

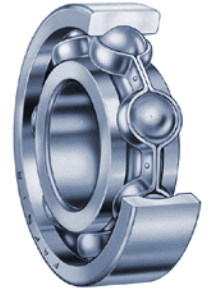

- Ensure the bearings are greaseable
- Ensure greases are compatible
- Lock Out/Tag Out Motor

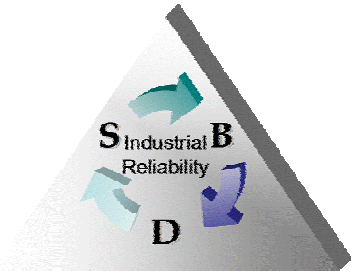

# Greasing Procedure

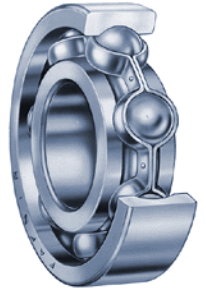

1. Wipe grease from pressure fitting and remove any dirt and debris
2. Remove the grease relief plug
3. Add Grease (see table)
4. Operate motor for 30 – 40 minutes with grease relief plug removed (some recommend up to 2 hours)
5. Re-install grease relief plug

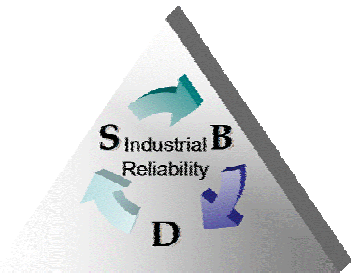

# Why De-Energized?

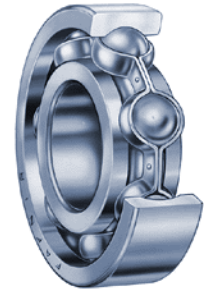

- Couetti Flow
- Greater chance of forcing contamination
- Additional pressure
- Safety
- Running?
  - You must decide
  - Understand Risk

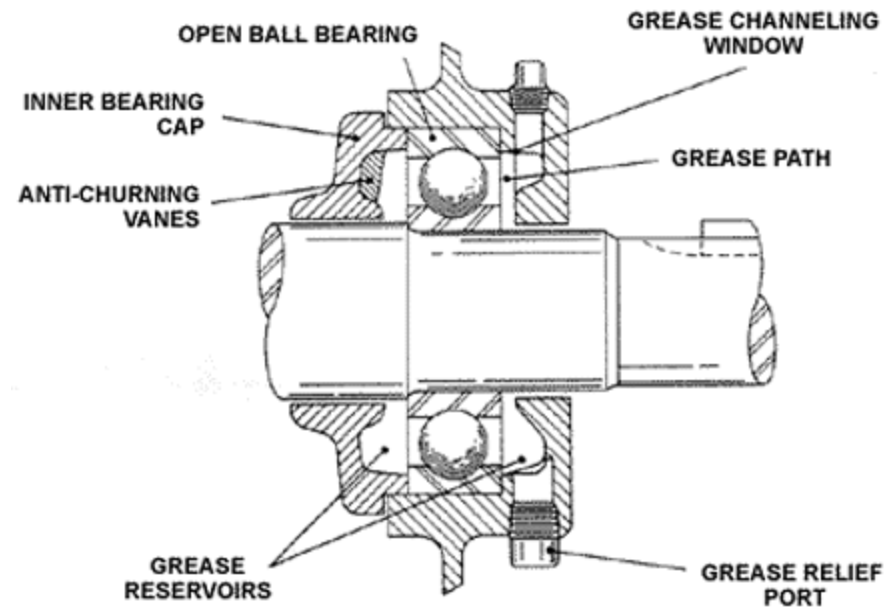

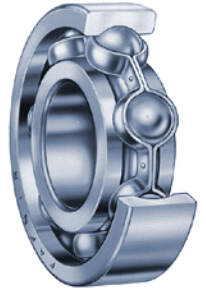
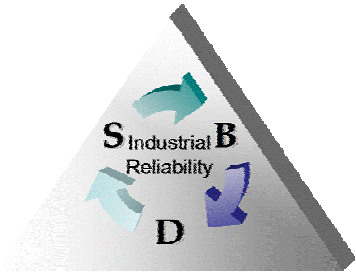

# Troubleshooting

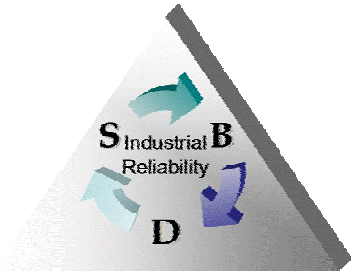

# Improper Lubrication

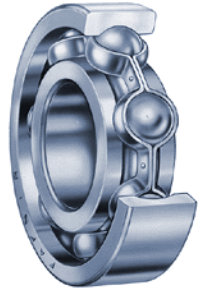

- Spalling
- Too much/too little
- Additives and thickener
- Look like fatigue failure when too little

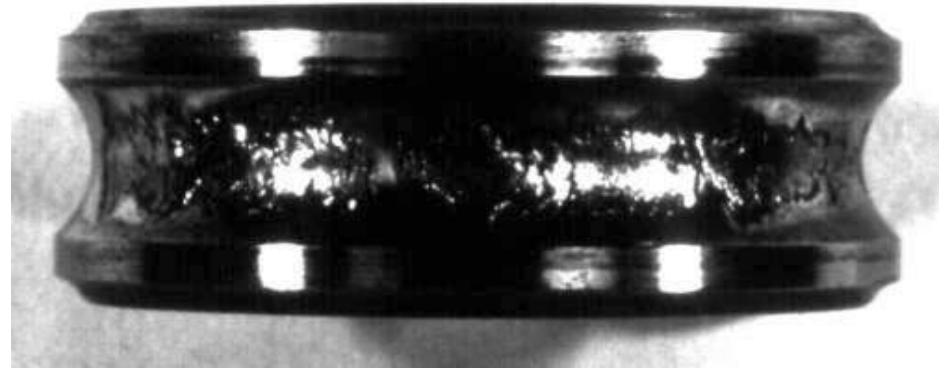

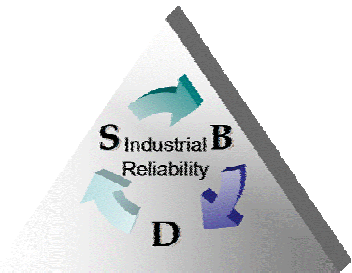

# Electrical Discharge

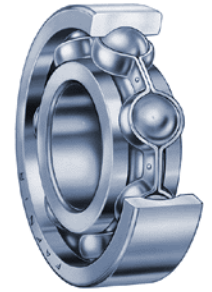

- Capacitive buildup and discharge
- Insulate one or both bearings (caution)
  - Insulated housing
  - Hybrid ceramic (races or balls)
- Why VFD's?

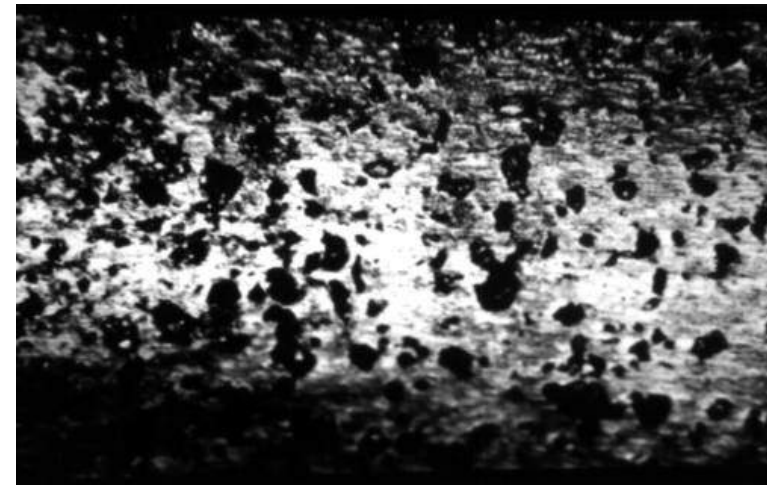
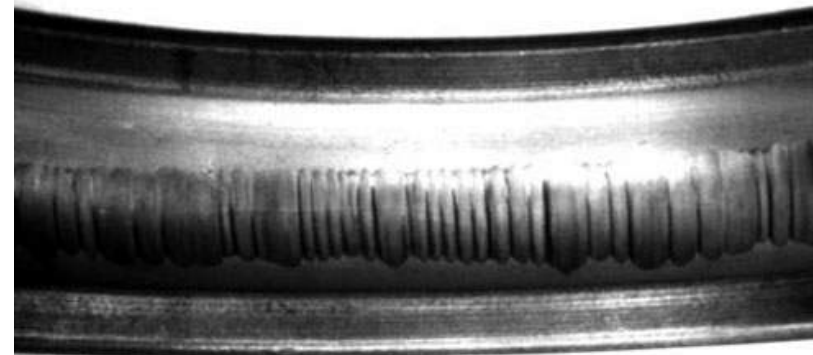

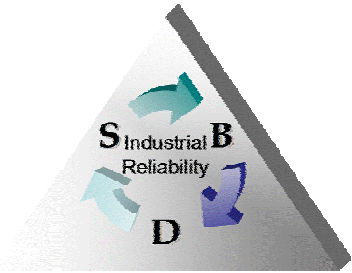

# Fatigue

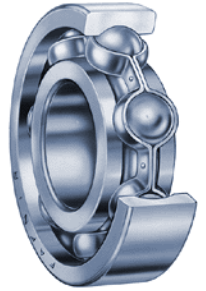

- General wear and tear
- Age related
- Accelerated based upon:
  - Bearing fits
  - Lubrication
  - Operating temp
  - Other





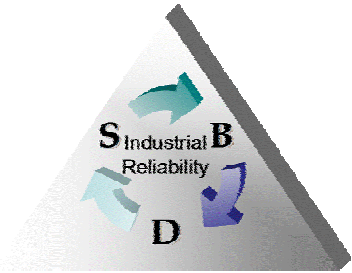

# Loss of Clearance

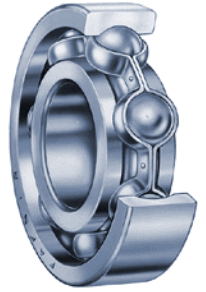

(c)2005, SBD

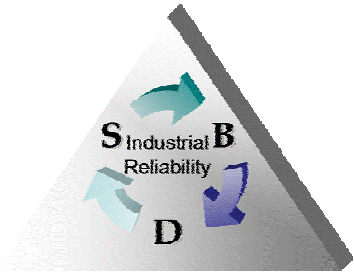

# Bearing Misalignment

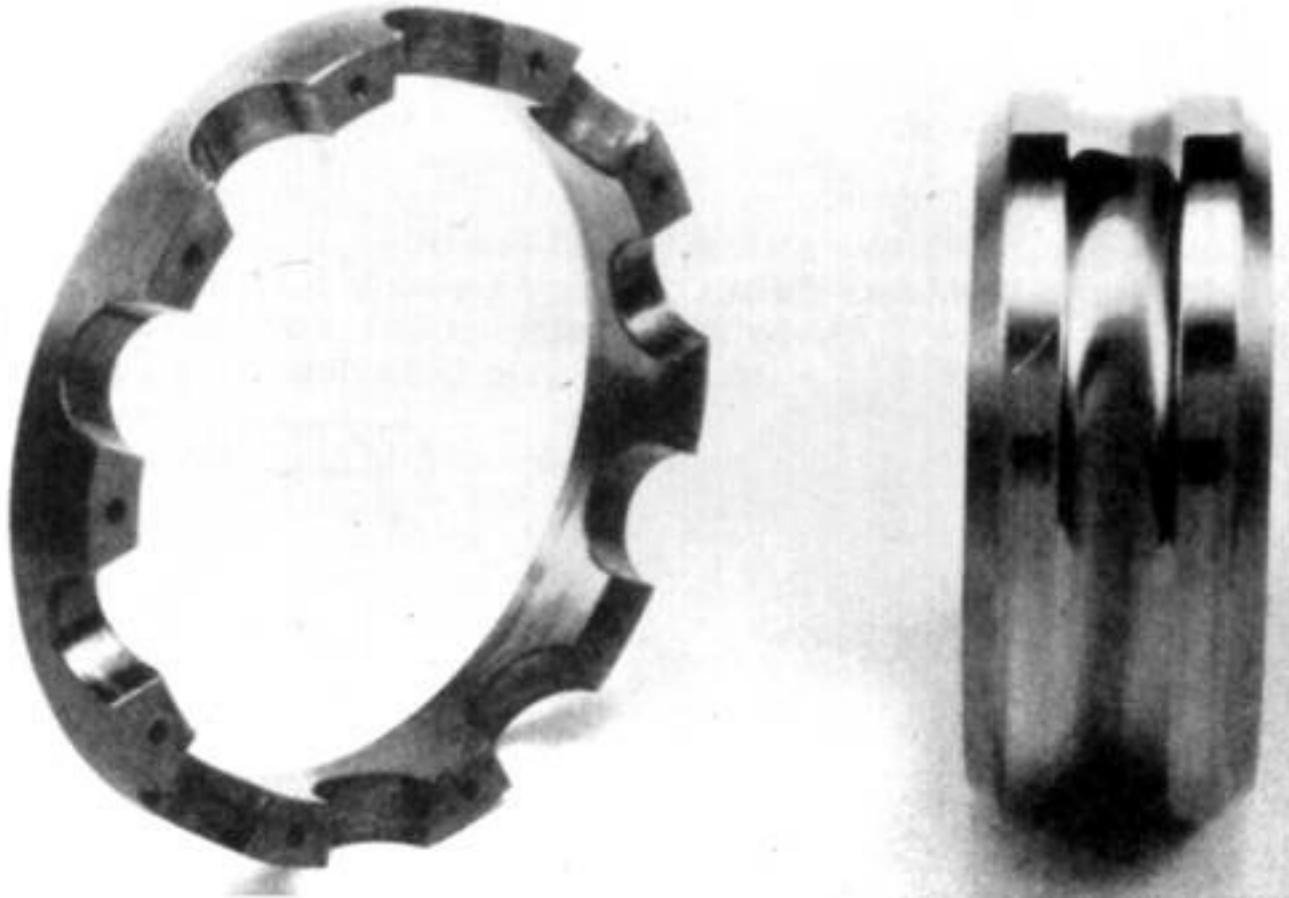
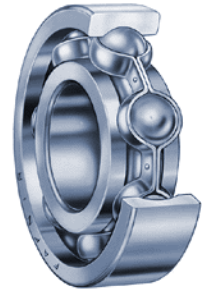

(c)2005, SBD

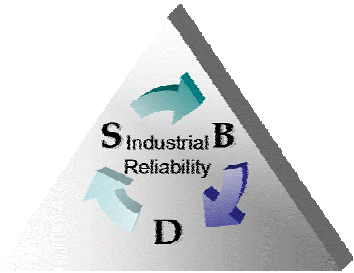

# Contamination

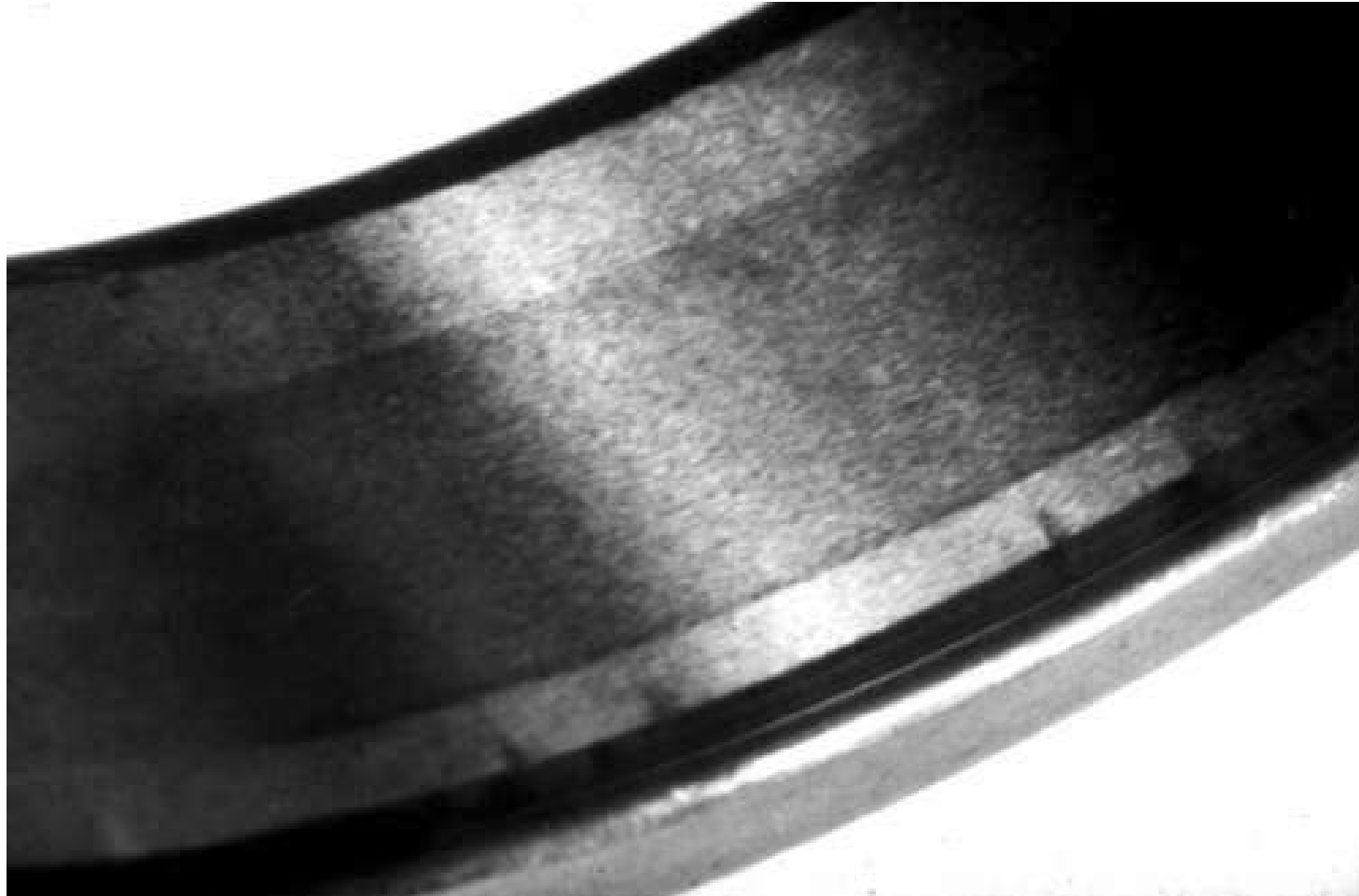
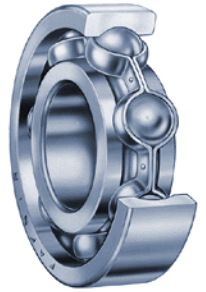

(c)2005, SBD

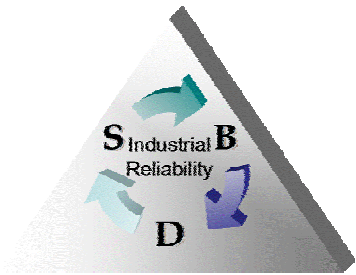

# Mounting Issues

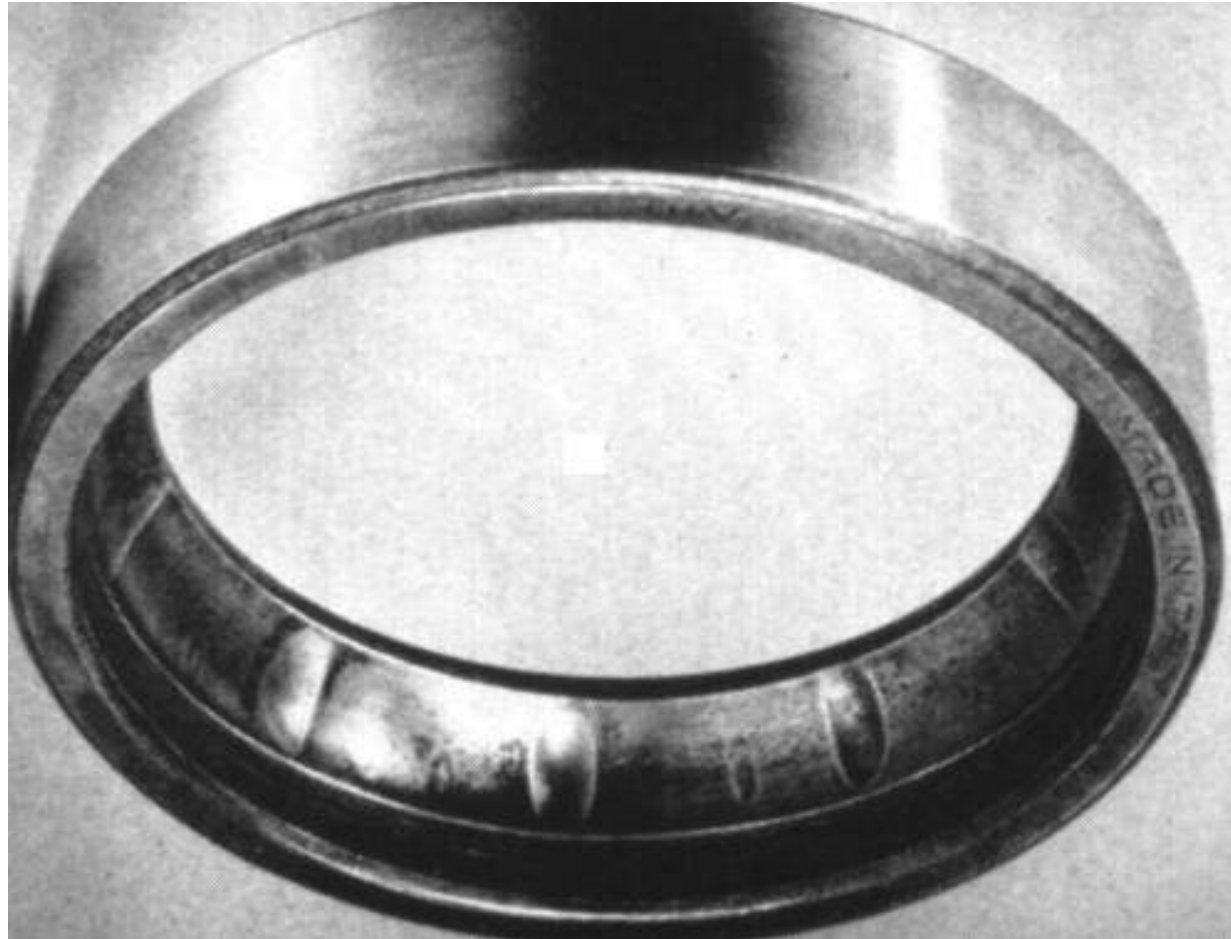
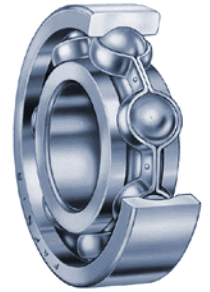

(c)2005, SBD

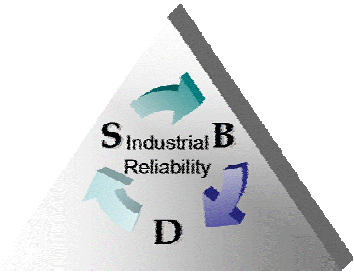

# Corrosion (Stationary)

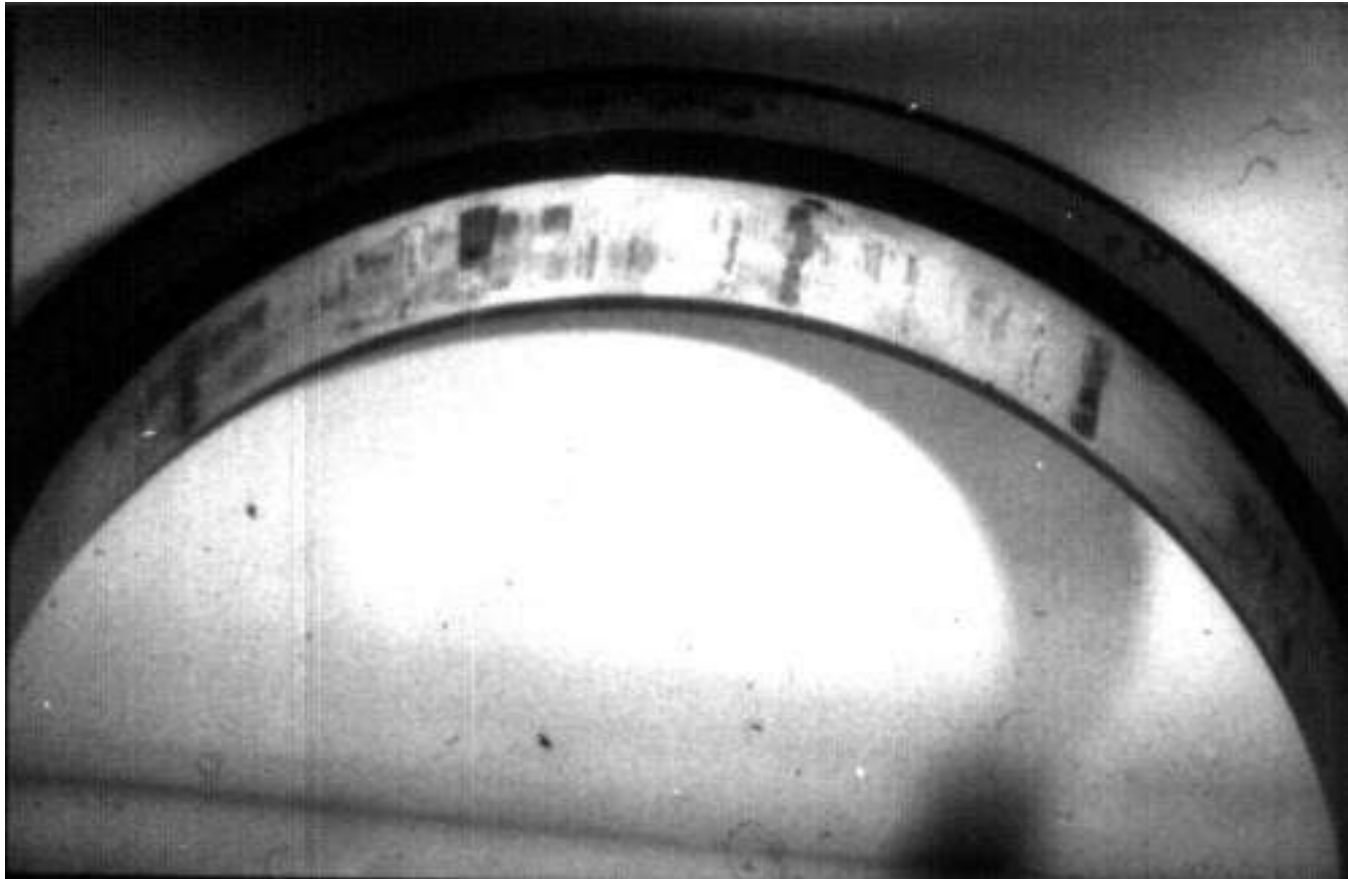
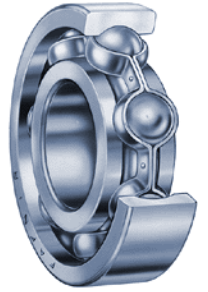

(c)2005, SBD

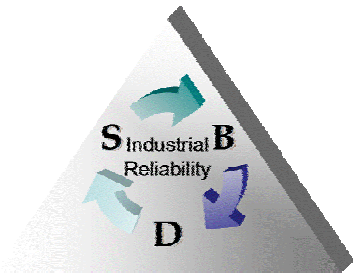

# False Brinelling

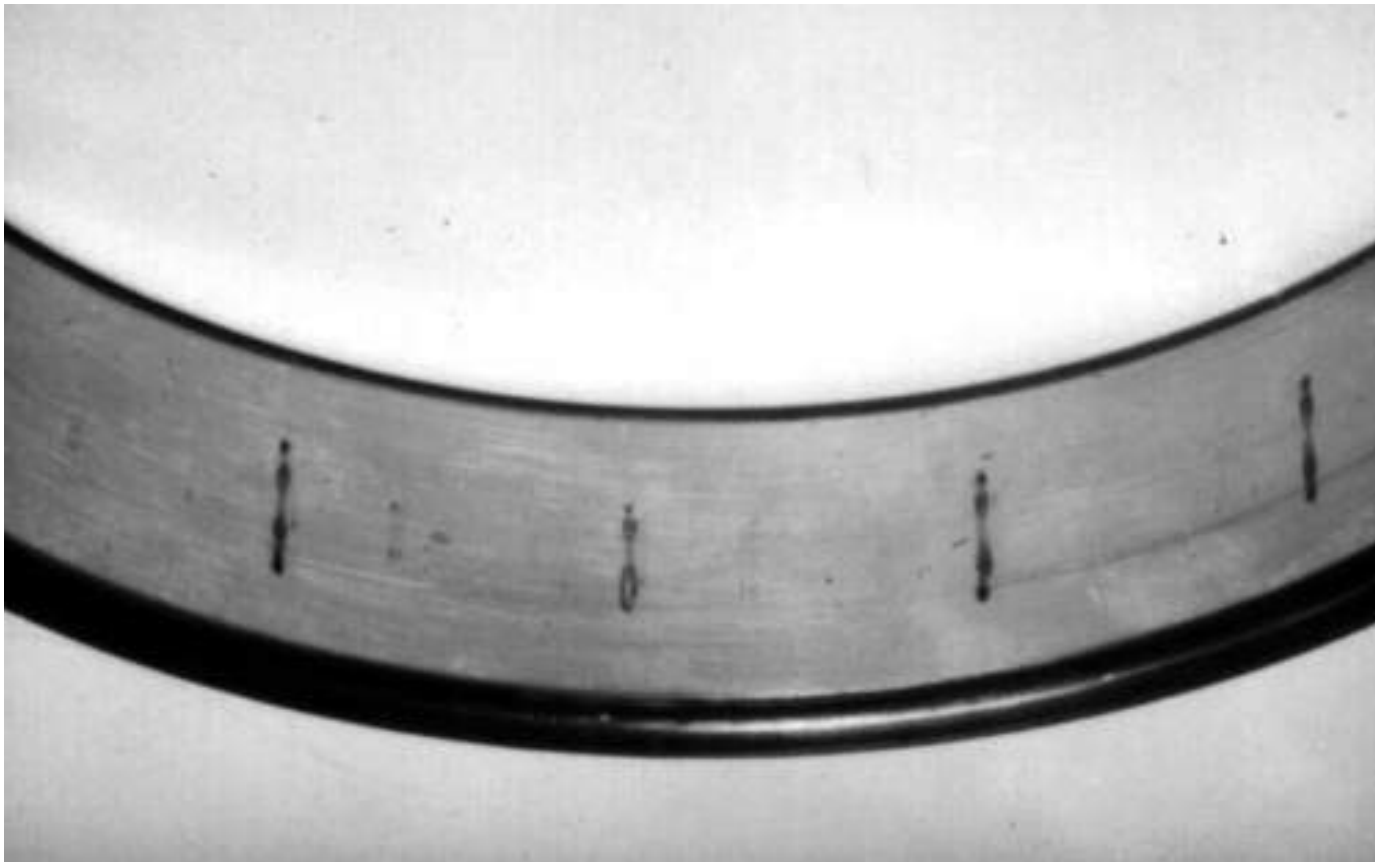
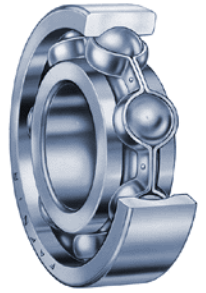

(c)2005, SBD



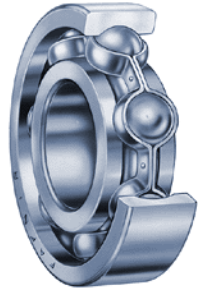
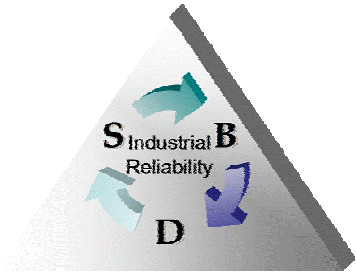

# Questions/Discussion

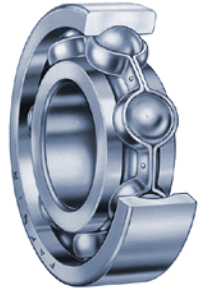
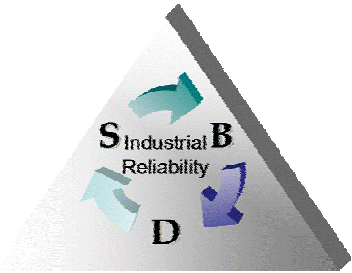

# ***SUCCESS by DESIGN***

5 Dogwood Ln  
Old Saybrook, CT 06475

Ph: 860 575-3087 Fax: 860 577-8537

<http://www.motordoc.net>

[howard@motordoc.net](mailto:howard@motordoc.net)

(c)2005, SBD